

Line Light

FLLN-i100

Lighting Picture



Lighting Dimension

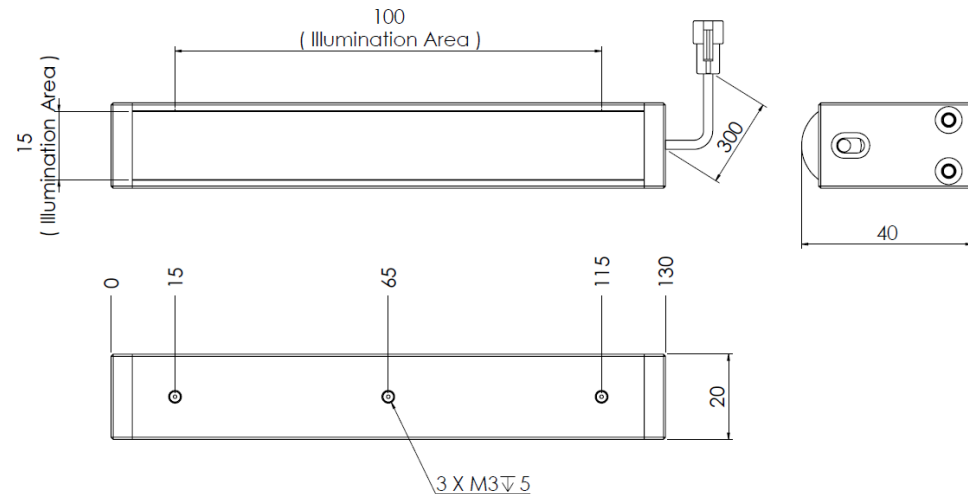

Unit in mm

Mechanical Information	
Casing Material	Aluminium + Acrylic
Weight	170g
Operating Temperature	0°C to 40°C, Humidity 20%-85%
Storage Temperature	-20°C to 60°C, Humidity 20%-85%
Lighting Dimension, WxLxH	20.0 x 130.0 x 40.0mm
IP Rating	IP40



FLLN-i100

Asia Office: www.falconmv.com, Europe Office: www.falcon-illumination.de
Form No: DSG-FR001 / Rev 1.7 / Date: 2022-01-11 / JY
© FALCON MV – All rights reserved conform to ISO 16016

Led Colour	RED(R24)	WHITE(W)
Optical Information		
Wavelength / Color temperature	626nm	xy=(0.31,0.32)
Illumination (Number of LED)	10	12
Illumination Area	100 x 15 mm	
Led Package	P4	
Eye Safety (EN 62471:2008)	Exempt Group	
Optimal Working Distance	10-100 mm	

Continuous Mode	Voltage Drive (With resistor)		Current Drive (Without resistor)	
	R24	W	R24	W
Supply Voltage To Controller	24VDC \pm 2%		21VDC \pm 2%	19VDC \pm 2%
Lighting Forward Voltage, Vf	20.0 V	18.0 V	20.0 V	18.0 V
Max. Current	0.05A (MAX)	0.20A (MAX)	0.05A (MAX)	0.20A (MAX)
Max. Power	1.20W	4.80W	1.05W	3.80W

Strobe Mode	Voltage Drive		Current Drive	
	R24	W	R24	W
Max. Lighting Supply Voltage	Pulsing at 24VDC to 48VDC, Recommended at 36VDC		Pulsing at 21VDC	Pulsing at 19VDC
Max. Current	0.13A (MAX)	0.50A (MAX)	0.13A (MAX)	0.50A (MAX)
Max. Trigger Pulse Duration	10 msec			
Duty Cycle	< 10%			

Ordering Part Number	Controller Type	Description
FLLN-i100-R24/W	Voltage Drive	With Resistor (Use in both constant voltage/ current power supply)
FLLN-i100-R24/W-0	Current Drive	Without Resistor (0 Ohm) (Only use in constant current power supply)



Connection		(Voltage & Current drive)		
Connector Type (Default):	Pin	Signal	Cable Color	
	1	LED +	Black/White	
	2	N.C.	---	
	3	LED -	Black	
Cable Length out from lighting:		300 mm		

Additional Information	Details
Life span in continuous mode	20,000 hours
Life span in strobe light mode	
Lighting drop to 50% intensity (at 25°C ambient temperature)	50,000 hours
Supply Ripple Voltage	$\leq V_s \pm 5\%$
Reverse Battery Protection	YES
Cooling Method	Natural air-cooling
Additional Cooling Method	Attached to machine part for better heat dissipation
Intensity Controller Selection	PSA-Series, PSD-Series, LIC-Series
CE Conformity	YES
ISO 9001:2015	MY11/00845



Disclaimer

IMPORTANT NOTICE:

ALL PRODUCT, PRODUCT DATA SHEET AND DATA ARE SUBJECT TO CHANGE WITHOUT NOTICE TO IMPROVE QUALITY, RELIABILITY, FUNCTION, DESIGN OR OTHERWISE.

Other disclaimers:

- 1) FALCON MV (M) SDN.BHD (termed as FALCON), its affiliates, agents, distributors and employees, and all persons acting on its or their behalf (FALCON collectively), disclaim any and all liability for any errors, inaccuracies or incompleteness contained in any datasheet or in any other disclosure relating to any product.
- 2) FALCON makes no warranty, representation or guarantee regarding the suitability of the products for any particular purpose or the continuing production of any product. To the maximum extent permitted by applicable law, FALCON disclaims:
 - (i) any and all liability arising out of the application or use of any product,
 - (ii) any and all liability, including without limitation special, consequential or incidental damages, and
 - (iii) an and all implied warranties, including warranties of fitness for particular purpose, non-infringement and merchantability.
- 3) Information and statements regarding the suitability of products for certain types of applications are based on FALCON's knowledge of typical requirements that are often placed on our products datasheet for generic applications. Such statements or information are not binding statements about the suitability of products for a particular application. It is the customer's responsibility to verify and/or validate that a particular product with the properties described in our product data sheet is suitable for use in a particular application.
- 4) Parameters provided in product datasheets and/or specifications may vary in different applications and performance may vary over time. All operating parameters, including typical parameters, must be verified and/or validated for each customer application by the customer's technical experts.
- 5) Except as expressly indicated in writing, FALCON I's products are not designed for use in medical, life-saving, or life-sustaining applications or for any other application in which the failure of the product could result in personal injury or death. Customers using or selling our products not expressly indicated for use in such applications do so at their own risk and agree to fully indemnify and hold FALCON and its distributors harmless from and against any and all claims, liabilities, expenses and damages arising or resulting in connection with such use or sale, including attorneys fees, even if such claim alleges that FALCON or its distributor was negligent regarding the design or manufacture of the part. Please contact authorized FALCON personnel to obtain written terms and conditions regarding products designed for such applications.

